



目录

Contents

1、特点 Features.....	1
2、应用 Applications.....	1
3、性能 Performance	2
4、产品代码 Product Order Code	3
5、分档规则 Bin Regulations	6
6、光电特性图 The Photoelectric Characteristics Graph.....	8
7、产品及钢网尺寸 Product and PCB Pad Dimensions.....	10
8、回流焊特性 Reflow Soldering Characteristics	11
9、卷轴 Reel Dimensions.....	12
10、可靠性验证 Reliability.....	13
11、注意事项 Cautions	14

1、特点 Features

- ◆ 陶瓷封装, 高亮度, 高光效
Ceramic Substrate package , High brightness ,High efficiency
- ◆ 尺寸: 3.45mm*3.45mm
Size: 3.45mm*3.45mm
- ◆ 根据 ANSI 标准分档
According to the ANSI standard colour gamut
- ◆ 350mA@25°C分档
Binned at 350mA@25°C
- ◆ 适于 SMT 贴片
Compatible with SMT
- ◆ 发光角度: 120°
Viewing Angle: 120°
- ◆ 包装: 最大 1000 颗/卷
Package: Max: 1000pcs /reel



2、应用 Applications

建筑照明	Architectural
工业照明	Industrial
商业照明	Commercial
室内外照明	Indoor and outdoor area



3、性能 Performance

a) 绝对最大额定值 Absolute Maximum Ratings

参数 Parameter	符号 Symbol	最大参数值 Maximum Rating	单位 Unit
电流 Forward Current	I_F	1500	mA
工作温度 Operating Temperature	T_{opr}	-40~105	°C
存储温度 Storage Temperature	T_{stg}	-40~125	°C
ESD Classification(HBM)		Class 3B(JS-001)	
结温 Junction Temperature	T_j	150	°C

b) 光电参数 Electro-Optical Characteristics ($I_F=350mA, @25^\circ C$)

项目 Item	符号 Symbol	最小值 Min.	典型值 Typ.	最大值 Max.	单位 Unit
光通量 Luminous Flux	Φ	Refer to Flux Rank Distribution			Lm
正向电压 Forward Voltage	VF	2.7	2.9	3.2	V
热阻 Thermal Resistance	----	----	3.0	----	°C/W
发光角度 Viewing Angle	2 θ 1/2	----	120	----	°

4、产品代码 Product Order Code

TG - B1 - 1B - S1 - AB9
① ② ③ ④ ⑤

- ① 产品型号 Product Type
- ② 显色指数 Ra level
- ③ 色温区块 Colour Area
- ④ 亮度等级 Brightness Level
- ⑤ 电压等级 VF Level

a) 出货标签(例) Shipping label (e.g.)

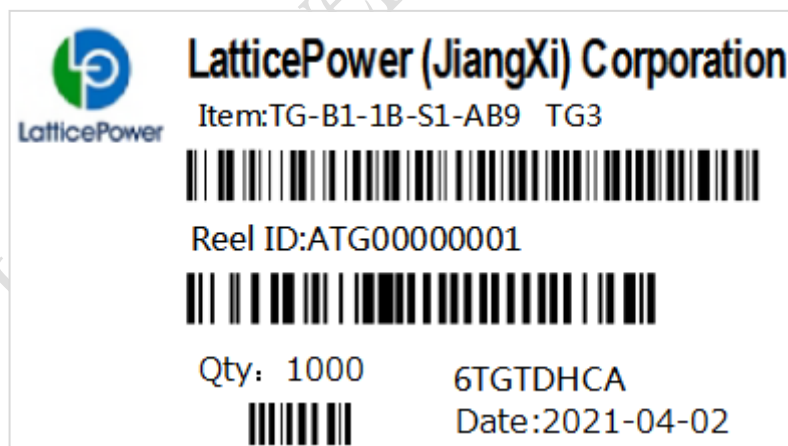

b) 亮度分档 Luminous Flux Binning (IF =350mA,@25°C)

Bin	symbol	Min.	Max.	Unit
N1	IV	150	160	lm
P1	IV	160	170	
Q1	IV	170	180	
R1	IV	180	190	
HB	IV	190	210	
W15	IV	210	230	

备注 Notes :

✧ 光通量测量误差范围±7%

Luminous flux measurement tolerance: ±7%

c) 电压分档 Forward Voltage Binning (IF =350mA,@25°C)

Bin	symbol	Min.	Max.	Unit
AB8	VF	2.6	2.8	V
AB9	VF	2.8	3.0	
ABA	VF	3.0	3.2	

备注 Notes :

✧ 电压测量误差范围±0.06V

Tolerance is ±0.06V on voltage measurements

d) 显指分档 Ra Groups (IF =350mA,@25°C)

Bin	symbol	Min.	Max.	R9
B0	CRI	67	80	/
B1	CRI	70	80	/
H1	CRI	80	90	Min.0

备注 Notes :

✧ 显指测量误差范围±2

Tolerance is ±2 on CRI measurements



e) 亮度分布 Flux Rank Distribution (IF =350mA,@25°C)

CRI 70

■ 供货等级 Available Rank

CCT	CIE	CRI		Flux Rank		
5700	2	70	Q1	R1	HB	W15
6500	1	70	Q1	R1	HB	W15

LatticePower Semiconductor

5、色区分档规则 Color Bin Regulations (IF =350mA,@85°C)

a) 色区图 CIE Chromaticity Diagram

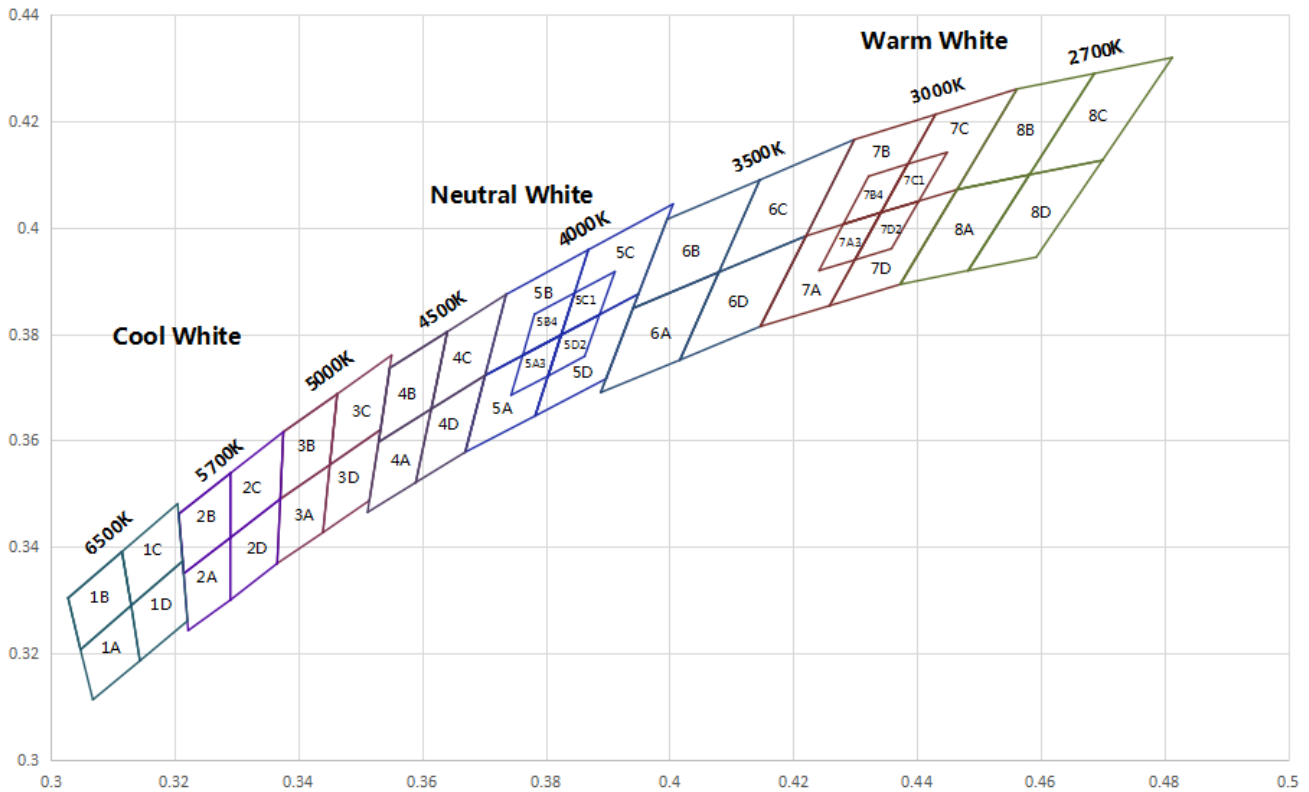

b) ANSI Bin 定义 ANSI Color bin definitions

色区	X	Y	色区	X	Y	色区	X	Y	色区	X	Y
1A	0.3048	0.3207	1B	0.3028	0.3304	1C	0.3115	0.3391	1D	0.313	0.329
	0.313	0.329		0.3115	0.3391		0.3205	0.3481		0.3213	0.3373
	0.3144	0.3186		0.313	0.329		0.3213	0.3373		0.3221	0.3261
	0.3068	0.3113		0.3048	0.3207		0.313	0.329		0.3144	0.3186
2A	0.3215	0.335	2B	0.3207	0.3462	2C	0.329	0.3538	2D	0.329	0.3417
	0.329	0.3417		0.329	0.3538		0.3376	0.3616		0.3371	0.349
	0.329	0.33		0.329	0.3417		0.3371	0.349		0.3366	0.3369
	0.3222	0.3243		0.3215	0.335		0.329	0.3417		0.329	0.33
3A	0.3371	0.349	3B	0.3376	0.3616	3C	0.3463	0.3687	3D	0.3451	0.3554
	0.3451	0.3554		0.3463	0.3687		0.3551	0.376		0.3533	0.362
	0.344	0.3427		0.3451	0.3554		0.3533	0.362		0.3515	0.3487
	0.3366	0.3369		0.3371	0.349		0.3451	0.3554		0.344	0.3427



色区	X	Y	色区	X	Y	色区	X	Y	色区	X	Y
4A	0.353	0.3597	4B	0.3548	0.3736	4C	0.3641	0.3804	4D	0.3615	0.3659
	0.3615	0.3659		0.3641	0.3804		0.3736	0.3874		0.3702	0.3722
	0.359	0.3521		0.3615	0.3659		0.3702	0.3722		0.367	0.3578
	0.3512	0.3465		0.353	0.3597		0.3615	0.3659		0.359	0.3521
5A	0.367	0.3578	5B	0.3702	0.3722	5C	0.3825	0.3798	5D	0.3783	0.3646
	0.3702	0.3722		0.3736	0.3874		0.3869	0.3958		0.3825	0.3798
	0.3825	0.3798		0.3869	0.3958		0.4006	0.4044		0.395	0.3875
	0.3783	0.3646		0.3825	0.3798		0.395	0.3875		0.3898	0.3716
5A3	0.3744	0.3685	5B4	0.3763	0.376	5C1	0.3825	0.3798	5D2	0.3804	0.3721
	0.3763	0.376		0.3782	0.3837		0.3847	0.3877		0.3825	0.3798
	0.3825	0.3798		0.3847	0.3877		0.3912	0.3917		0.3887	0.3836
	0.3804	0.3721		0.3825	0.3798		0.3887	0.3836		0.3863	0.3758
6A	0.3889	0.369	6B	0.3941	0.3848	6C	0.408	0.3916	6D	0.4017	0.3751
	0.3941	0.3848		0.3996	0.4015		0.4146	0.4089		0.408	0.3916
	0.408	0.3916		0.4146	0.4089		0.4299	0.4165		0.4221	0.3984
	0.4017	0.3751		0.408	0.3916		0.4221	0.3984		0.4147	0.3814
7A	0.4147	0.3814	7B	0.4221	0.3984	7C	0.4342	0.4028	7D	0.4259	0.3853
	0.4221	0.3984		0.4299	0.4165		0.443	0.4212		0.4342	0.4028
	0.4342	0.4028		0.443	0.4212		0.4562	0.426		0.4465	0.4071
	0.4259	0.3853		0.4342	0.4028		0.4465	0.4071		0.4373	0.3893
7A3	0.4242	0.3919	7B4	0.4281	0.4006	7C1	0.4342	0.4028	7D2	0.43	0.3939
	0.4281	0.4006		0.4322	0.4096		0.4385	0.4119		0.4342	0.4028
	0.4342	0.4028		0.4385	0.4119		0.4449	0.4141		0.4403	0.4049
	0.43	0.3939		0.4342	0.4028		0.4403	0.4049		0.4359	0.396
8A	0.4373	0.3893	8B	0.4465	0.4071	8C	0.4582	0.4099	8D	0.4483	0.3919
	0.4465	0.4071		0.4562	0.426		0.4687	0.4289		0.4582	0.4099
	0.4582	0.4099		0.4687	0.4289		0.4813	0.4319		0.47	0.4126
	0.4483	0.3919		0.4582	0.4099		0.47	0.4126		0.4593	0.3944

备注 Notes :

- ◇ 色度坐标 (x, y) 来自 CIE1931 色度图
The chromaticity coordinates(x,y)is derived from the CIE 1931 chromaticity diagram
- ◇ 测试分选设备用于光通量 (lm) 和 CIE1931 色度坐标 (x, y) 测试。
Testing & Sorting Machine is for the luminous flux(lm) and the CIE1931 chromaticity coordinates(x,y) testing.
- ◇ 色度坐标 (x, y) 存在±0.006 公差。
The chromaticity coordinates(x,y) guarantee should be added ±0.006 tolerance.

6、光电特性图 The Photoelectric Characteristics Graph

a)、光谱图 Color Spectrum, Ta=25°C

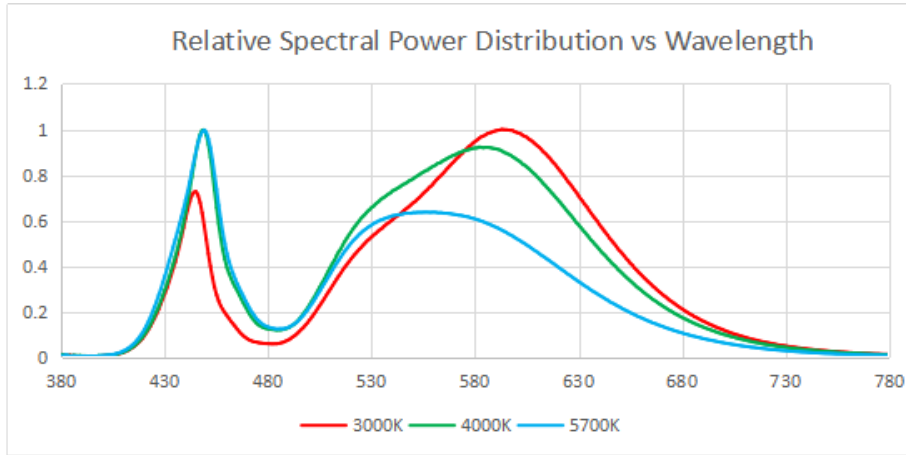

b)、Forward Voltage vs. Forward Current, Ta=25°C

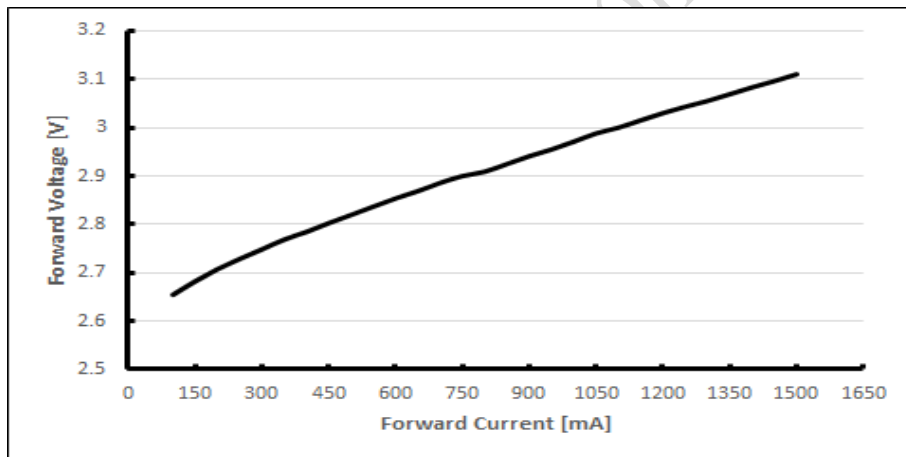

c)、Forward Current vs. Relative Luminous Flux, Ta=25°C

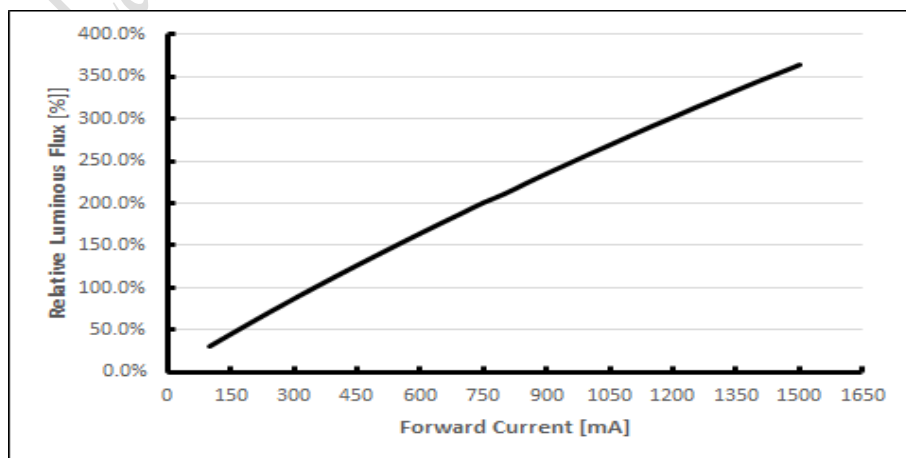

d) 、 Forward Current vs. CIE X, Y Shift, Ta=25°C

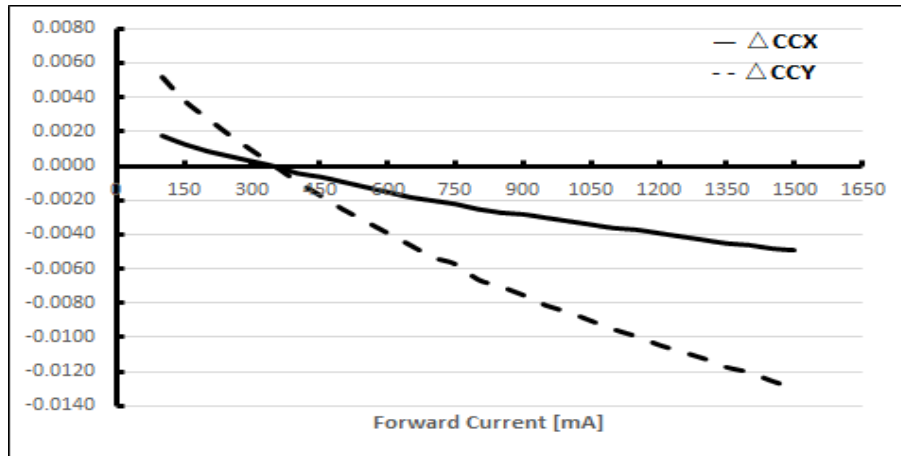

e) 、 Maximum Forward Current vs. Ambient Temperature, Tj(max.)=150°C

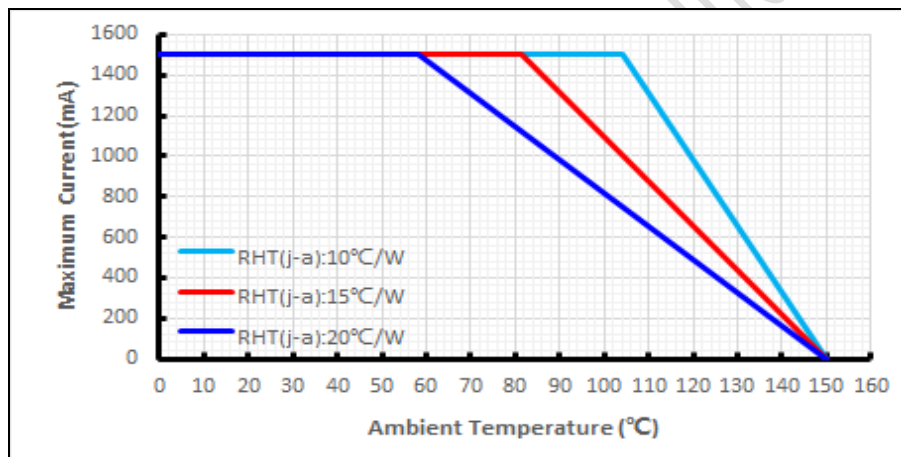

◇ 备注 Notes:

最大正向电流由 LED 结和环境之间的热阻决定。最终产品的设计方式应最大限度地减少从焊点到环境的热阻，以优化灯的寿命和光学特性。

The maximum forward current is determined by the thermal resistance between the LED junction and ambient. It is crucial for the end product to be designed in a manner that minimizes the thermal resistance from the solder point to ambient in order to optimize lamp life and optical characteristics

7、产品及钢网尺寸 Product and PCB Pad Dimensions

Product Dimensions:

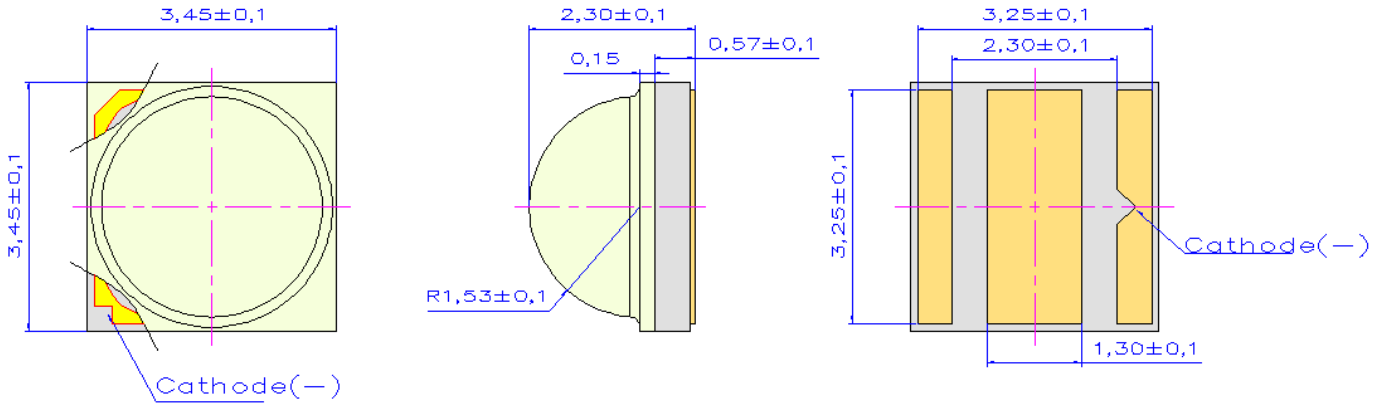

PCB Pad Dimensions:

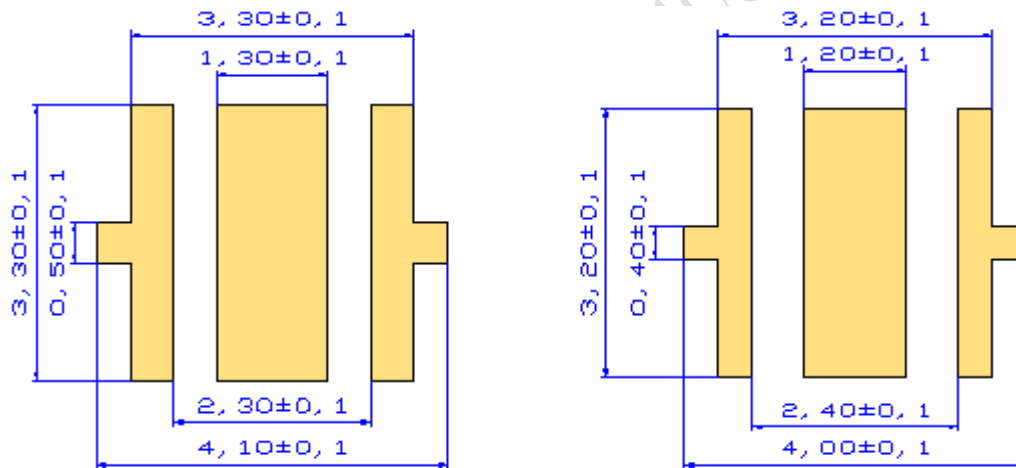

建议 PCB 焊盘

建议钢网

备注 Notes:

- ◇ 所有尺寸均以 mm 为单位
All dimensions are in millimeters
- ◇ 尺寸公差: $\pm 0,1$ mm
Dimension tolerance: $\pm 0,1$ mm

8、回流焊特性 Reflow Soldering Characteristics

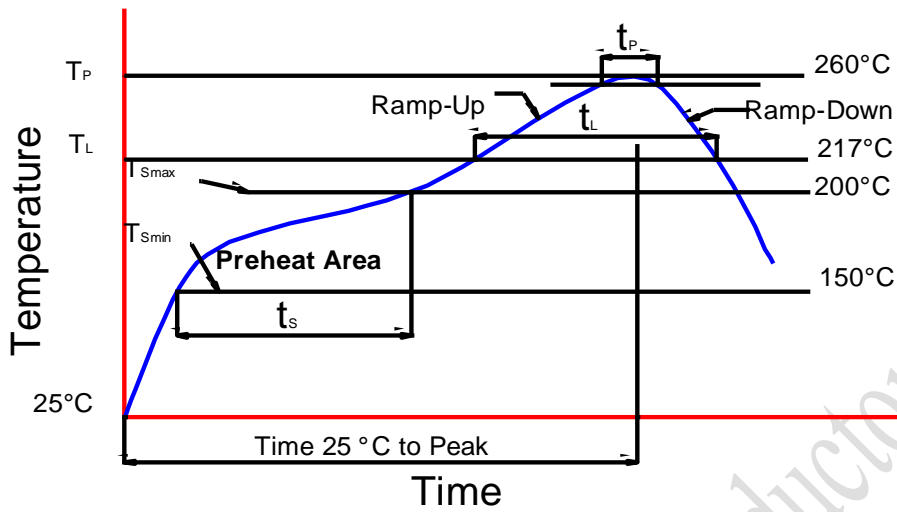

根据 EDEC-J-STD-020D 内容，参考以下内容。

Compatible with the JEDEC-J-STD-020D, using the parameters listed below.

特制参数 Profile Feature	无铅焊料 Lead-Free Solder
平均上升速率 (T _{Smax} 至 T _P) Average Ramp-Up Rate (T _{Smax} to T _P)	3 °C/sec max.
预热: 温度最小值 (T _{Smin}) Preheat: Temperature Min (T _{Smin})	150
预热: 最高温度 (T _{Smax}) Preheat: Temperature Max (T _{Smax})	200
预热: 时间 (t _{Smin} 到 t _{Smax}) Preheat: Time (t _{Smin} to t _{Smax})	60-180 secs
回流温度 (T _L) Time Maintained Above: Temperature (T _L)	217°C
回流时间 (t _L) Time Maintained Above: Time (t _L)	60-150 secs
峰值/分类温度 (T _P) Peak/Classification Temperature (T _P)	255±5°C
实际峰值温度 (t _p) 在 5°C 以内的时间 Time Within 5°C of Actual Peak Temperature (t _p)	20~40 secs
降低速率 Ramp-Down Rate	5°C/sec max.

9、卷轴 Reel Dimensions

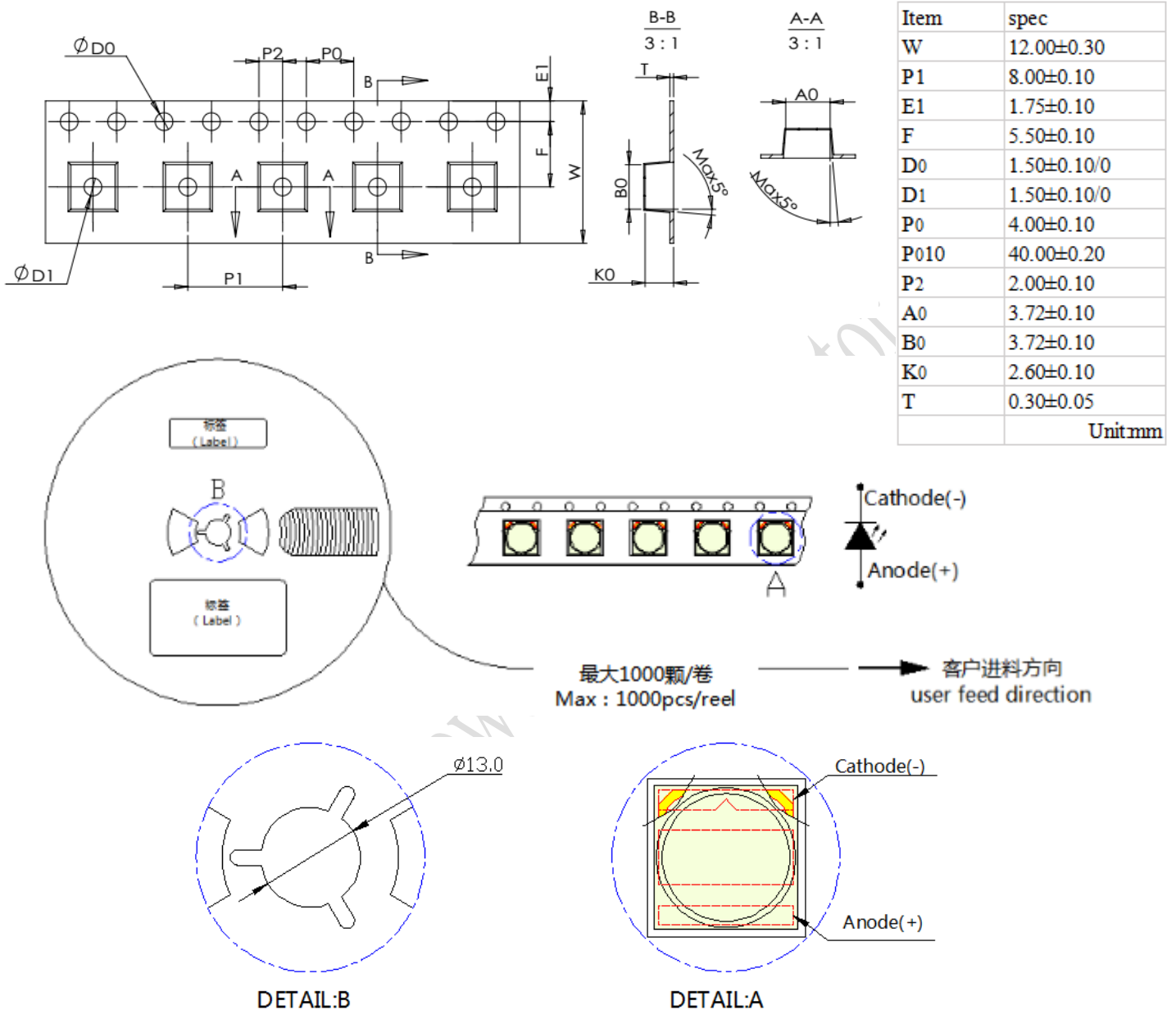

备注 Notes:

- ✧ 卷轴包装 1000pcs
 Reel:1000pcs.
- ✧ 卷轴包装方法符合 IJSC0806 (连续胶带上的电子元件包装)
 The tape packing method complies with IJSC0806(Packing of Electronic Components on Continuous Tapes.
- ✧ 当卷轴由于工作中断而重绕时, 载带上压力不应超过 10N, 否则 LED 可能会粘在盖带上
 When the tape is rewound due to work interruptions, no more than 10N should be applied to the embossed carrier tape.
 The LEDs may stick to the cover tape.

10、可靠性 Reliability

a) 测试和结果 Tests and Results

测试项目 Test Item	参考标准 Reference Standard	测试条件 Test Conditions	测试周期 Test Duration	失效标准 Failure Criteria#	失效数/测试数 Units Failed/Tested
可焊性 (回流焊) Solderability(Reflow Soldering)	JEITA ED=4701 303 303A	$T_{sld}=255\pm 5^{\circ}\text{C}$, 5sec, Lead-free Solder(Sn-3.0Ag-0.5Cu)	3times	#2	0/22
高低温循环 Temperature Cycle	JEITA ED=4701 100 105	-40°C (30min)~ 25°C (5min)~ 85°C (30min)~ 25°C (5min)	100cycles	#1	0/22
高温/低温储存 High/Low Temperature Storage	JEITA ED=4701 200 201/ JEITA ED=4701 200 202	$T_A=120^{\circ}\text{C}/T_A=-40^{\circ}\text{C}$	1000h	#1	0/22
高温老化 High Temperature Operating		$T_A=70^{\circ}\text{C}$, $I_F=1500\text{mA}$	1000h	#1	0/22
高温高湿老化 Temperature Humidity Operating		85°C , RH=85%, $I_F=1500\text{mA}$	1000h	#1	0/22

b) 失效判定 Failure Criteria

判定 Criteria #	项目 Items	条件 Conditions	失效判定 Failure Criteria
#1	正向电压 Forward Voltage (VF)	I_F	> 初始值×1.1 倍 > Initial value×1.1
	光通量 Luminous Flux (Φ_v)	I_F	< 初始值×0.7 倍 < Initial value×0.7
	反向电流 Reverse Current (IR)	$V_R=5V$	> 1uA > 1uA
#2	回流焊 Solderability	-	焊接面积 < 80% Less than 80% solder coverage

11、注意事项 Cautions

a) 操作注意 Handling Precautions



1) LED 上的压力会影响 led 的可靠性。应采取预防措施，以避免对 led 的强压力。在加热过程中不要对 led 施加压力。

Pressure on the LEDs will influence to the reliability of the LEDs. Precautions should be taken to avoid strong pressure on the LEDs. Do not put stress on the LEDs during heating.

2) LED 焊接完毕后不应重新焊接。如果重新焊接不可避免，那么在修复之前和修复之后都要仔细检查 LED 的特性。

Re-soldering should not be done after the LEDs have been soldered. If re-soldering is unavoidable, LED's characteristics should be carefully checked before and after such repair.

3) 不要将组装好的 pcb 堆在一起。由于 LED 的材料是软的，与 LED 组装的两个 PCB 之间的磨损可能会导致 LED 破坏性的故障。

Do not stack assembled PCBs together. Since materials of LEDs is soft, abrasion between two PCB assembled with LED might cause catastrophic failure of the LEDs.

4) 与标准的封装材料相比，硅胶通常更柔软，表面更容易吸引灰尘，如果不能保证最低程度的灰尘和灰尘颗粒，在部件焊接后，必须在表面使用合适的清洗液。

Compared to standard encapsulants, silicone is generally softer, and the surface is more likely to attract dust, In cases where a minimal level of dirt and dust particles cannot be guaranteed, a suitable cleaning solution must be applied to the surface after the soldering of components.

5) 灯具材料中释放的挥发性有机化合物(VOCs)可以穿透 LED 的硅树脂封装，暴露在热量和光子能量下会变色。结果可能是灯具的光输出有重大损失。

VOCs (Volatile organic compounds) emitted from materials used in the construction of fixtures can penetrate silicone encapsulants of LED and discolor when exposed to heat and photonic energy. The result can be a significant loss of light output from the fixture.

6) 安装 led 时，不要使用释放有机蒸汽的粘合剂。

Attaching LEDs, do not use adhesives that outgas organic vapor..



7) LED 对 ESD (Electro-Static Discharge, ESD)敏感。以下是晶能半导体公司为减少这些影响而提出的一些建议。

LED is sensitive to Electro-Static Discharge (ESD). Below is a list of suggestions that LatticePower Semiconductor purposes to minimize these effects.

a. ESD(静电放电)

静电放电(ESD)定义为两个物体接触时释放出的静电。虽然大多数 ESD 事件被认为是无害的,但在许多工业环境中,在生产和存储期间,它可能是一个代价比较大的问题。ESD 对 LED 的损害可能导致产品显示出不同寻常的特性,例如:一反向泄漏电流的增加降低了开启电压

ESD (Electro Static Discharge)

Electrostatic discharge (ESD) is the defined as the release of static electricity when two objects come into contact. While most ESD events are considered harmless, it can be an expensive problem in many industrial environments during production and storage. The damage from ESD to an LED may cause the product to demonstrate unusual characteristics such as: - Increase in reverse leakage current lowered turn-on voltage.

-LED 在低电流时发射异常 Abnormal emissions from the LED at low current

以下建议可以帮助减少 ESD 发生的可能性。

The following recommendations are suggested to help minimize the potential for an ESD event.

一个或多个工作区域建议:

One or more work area suggestions:

-电离风扇设置 Ionizing fan setup

-导电材料制成的防静电台面/搁板垫 ESD table/shelf mat made of conductive materials

-防静电安全容器 ESD safe storage containers

一个或多个人员建议选择::

One or more personnel suggestion options:

-防静电腕带 Antistatic wrist-strap

-防静电材料鞋 Antistatic material shoes

-防静电衣服 Antistatic clothes

环境控制:

Environmental controls:

-湿度控制(干燥环境下防静电效果较差) Humidity control (ESD gets worse in a dry environment)

b) 清洗 Cleaning

1) 建议使用异丙醇进行清洗。如果使用其他溶剂，必须保证这些溶剂不溶解包装或树脂。不建议使用超声波清洗。超声波清洗可能会对 LED 造成损坏。

We suggests using isopropyl alcohol for cleaning. In case other solvents are used, it must be assured that these solvents do not dissolve the package or resin. Ultrasonic cleaning is not recommended. Ultrasonic cleaning may cause damage to the LED.

c) 存储 Storage

➤ 不要将 LED 放在潮湿的地方，存放温度在 5°C~30°C 之间，相对湿度在 30% 以下。
Do not place the LED in damp places, Storage temperature between 5 °C and 30 °C, Relative humidity under 30%.

➤ 打开包装后使用注意事项 Use Precaution after Opening the Packaging

a) 开包后推荐条件 Recommend conditions after opening the package

- 密封/温度: 5~30°C 湿度: 小于 60%

- Sealing / Temperature : 5 ~ 30°C Humidity : less than RH60%

b) 如果包装已打开超过 168H(MSL 3) 或湿度指示卡颜色发生变化，应在 65±5°C 条件下干燥 10-24H

If the package has been opened more than 168 hours (MSL 3) or the color of the Humidity indicator card changes, components should be dried for 10-24hr at 65±5°C